



**b[®] brevetti
stendaito**

GENERAL INDUSTRY

DRAG CHAINS RANGE

Drag Chain Solution Provider

Since 1968, Brevetti Stendalto has been a leading company in the engineering and manufacture of drag chain solutions for mobile equipment and machinery. Our 50-year experience and long track record of successful applications give us the capability to offer, produce and deliver perfect solutions for our customers. Out of a range of 6,000+ catalogue part numbers we can always find the right product for any application. All catalogue products are available on stock and can be delivered in a very short lead time. Our Total Chain package, featuring chains populated with cables and hoses and supplied on transportation drums, is one of the most appreciated plug-and-play services. Customers can enjoy the benefits of a package, and order a time-saving solution with full warranty given by a single supplier. The outstanding quality of our products, our teamwork in all project phases, and the value our technical support at all levels, including installation, commissioning and maintenance, win customers' trust. Beside catalogue products we also offer a wide range of customised products and complete engineered solutions.

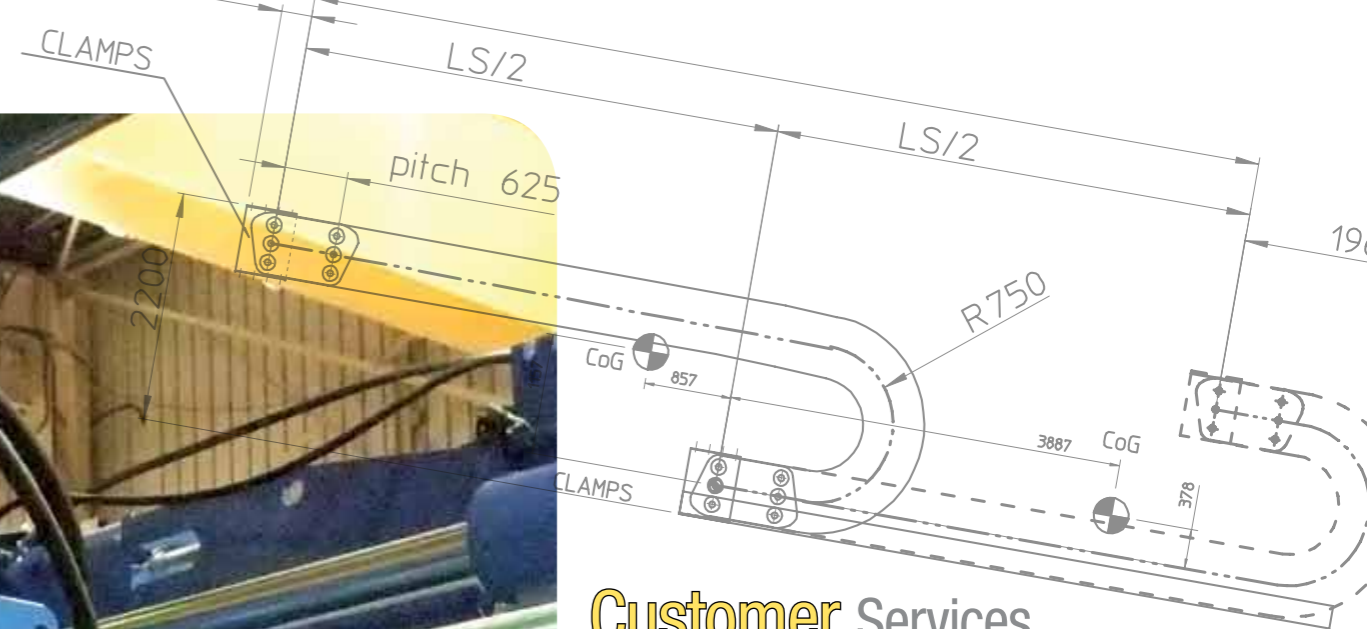

Customer Services

PRODUCTS

Brevetti Stendalto is the right partner to be a single supplier for multiple products.

With our product lines we can deliver various supply packages:

- Cable Chain.
- Populated Cable Chain with cables and hoses.
- Populated Cable Chain with cables and hoses with connectors.
- Populated Cable Chain with cables and hoses with connectors, ready for installation, delivered in cage or on drum.
- Various accessories for easy installation and maintenance.
- Installation and commissioning on site.

Main benefits from Brevetti Stendalto's offer:

- Easy installation.
- Cost savings through reduced installation time.
- Single supplier for several components.
- Warranty extended to the complete supply.

Our qualified staff can assist you in any region of the world



GENERAL PURPOSE



Brevetti Stendalto today offers a wide range of products, suitable for the most demanding and most creative applications, thanks to a great experience achieved in various industrial fields. Attention to the design, precision in the engineering process, and quality applied to production make Brevetti's products highly eclectic: chains can work both in self-supporting and sliding configuration, always providing the highest performance standards.

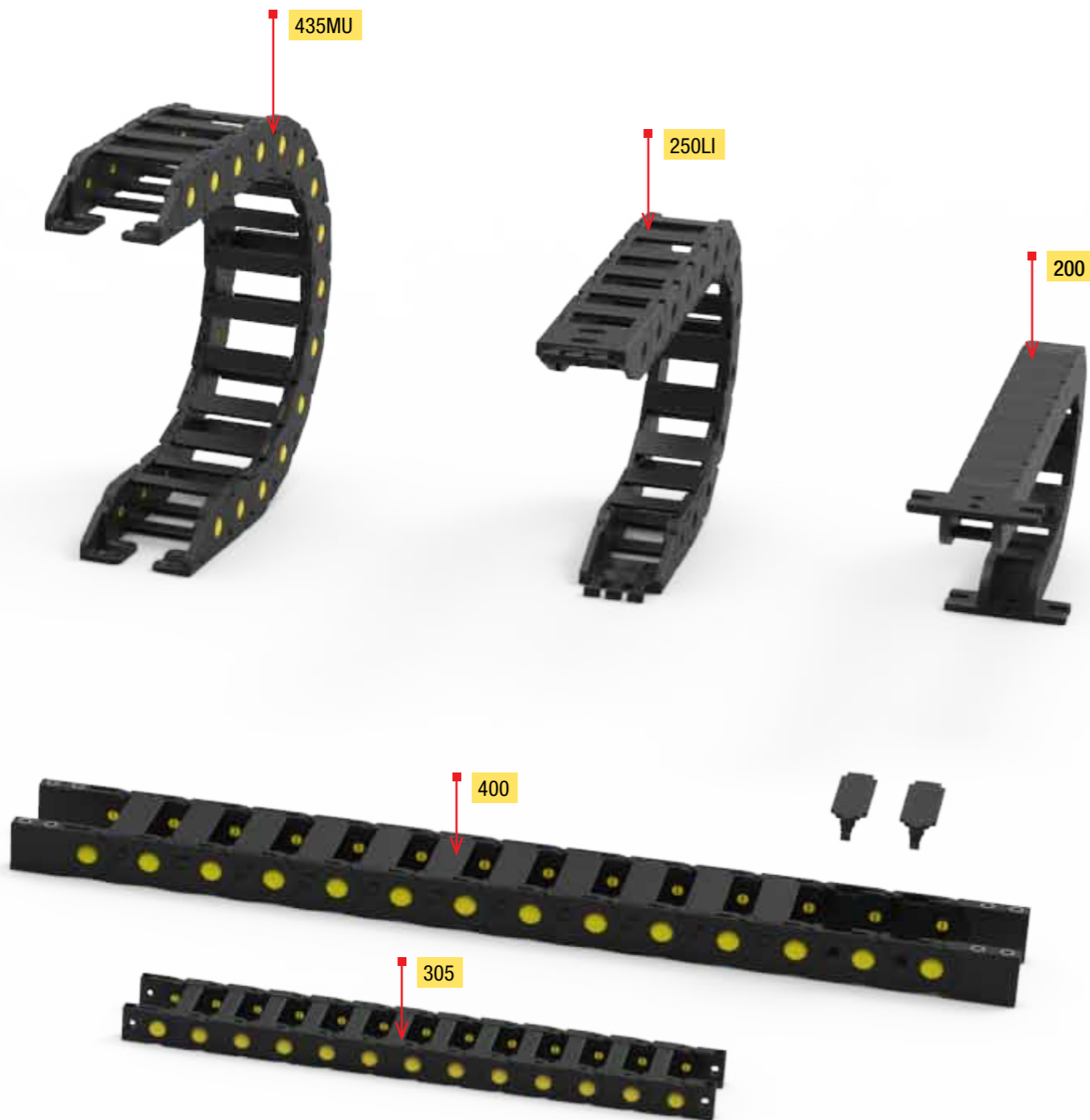

PROTECTION



Protecting cables and hoses is Brevetti Stendalto's core business, and this is exactly what the Protection Series does. Mainly used on machine tools, Protection chains prevent hot chips and dirt from getting inside the chain and damaging cables and hoses. Many OEM's in the world have experienced the quality of our chains, with or without coloured pins. We can even offer coloured pins customised with the customer's company colour.

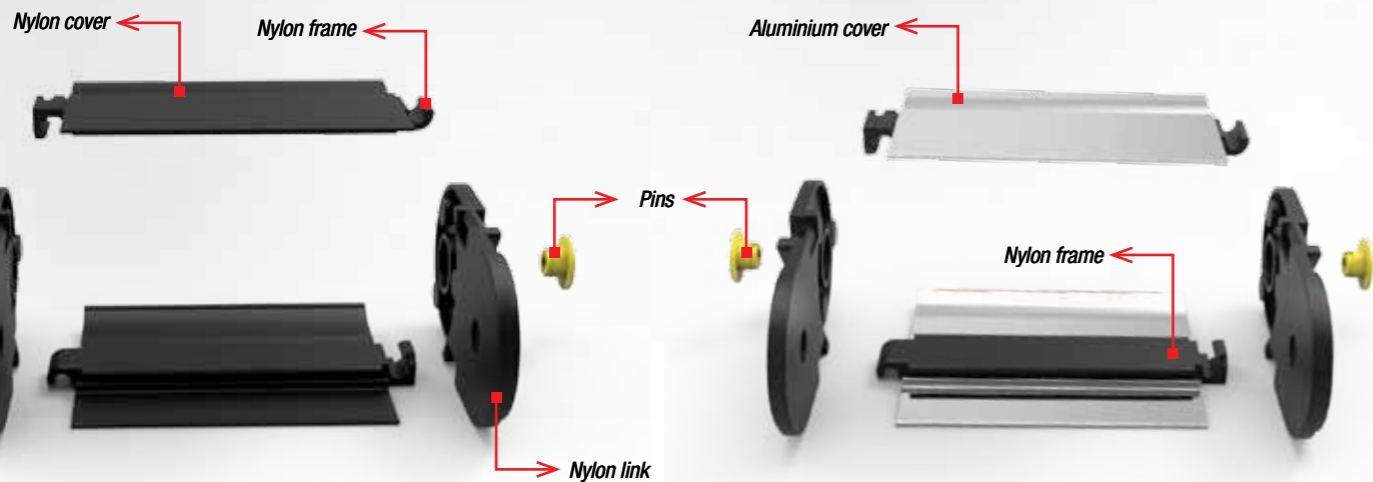
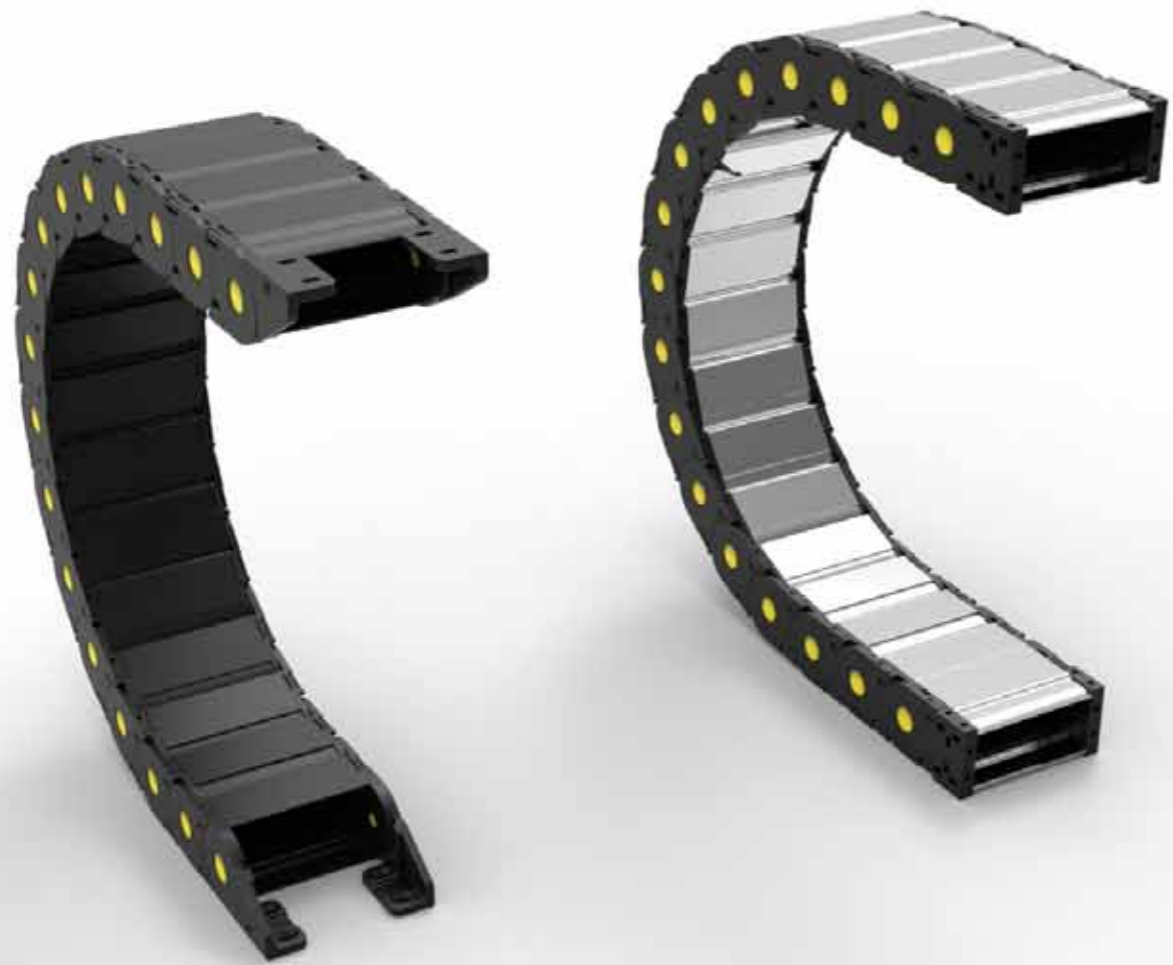

HEAVY DUTY



Brevetti Stendalto's heavy-duty cable chains are high-performance nylon and steel chains. The chains of this series are engineered to offer the best performance in the harshest environments and with the heaviest loads. The experience accumulated over the years with nylon and steel chains allows us to guide customers to the selection of the right product. All these chains can be customised in various ways: stainless-steel rods, machined aluminium crosspieces, support frames, special bend radius and counter-radius, specific cable segregation.

NYLON "H" SERIES

Brevetti's "H" Series provides increased strength compared to the traditional chains of the Heavy Series. All components of the H chains are designed with improved robustness.



STEEL LIGHT

Brevetti's innovative Y-link design for steel chains reduces chain weight without compromising performances.

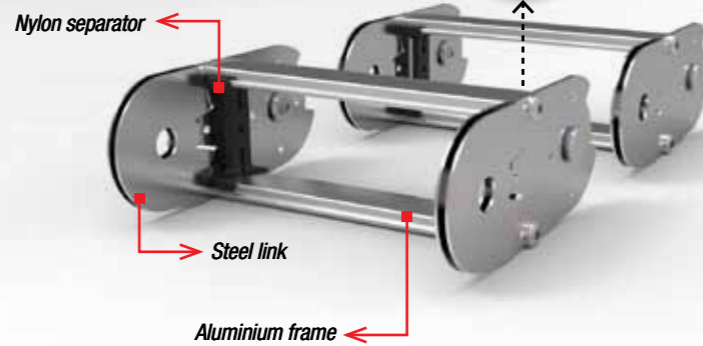
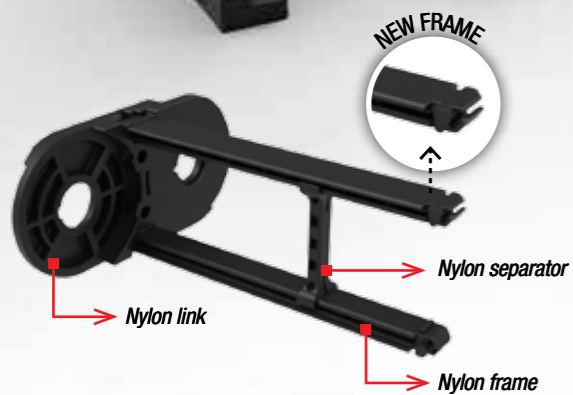

LONG STROKES



Sliding chains have been developed to cover any travel distance that reaches beyond self-supporting capacity. Beside the traditional chains of Brevetti's Sliding Series, the brand new "invisible roller" IR-Chain technology was introduced. IR-Chains feature a wider sliding surface, as well as integrated pop-up wheels that appear only when needed. Brevetti's innovative IR-Chain technology is the right solution for extremely long strokes, high speed, heavy added loads, or otherwise demanding applications, and offers great reliability, minimum wearing, easy maintenance.

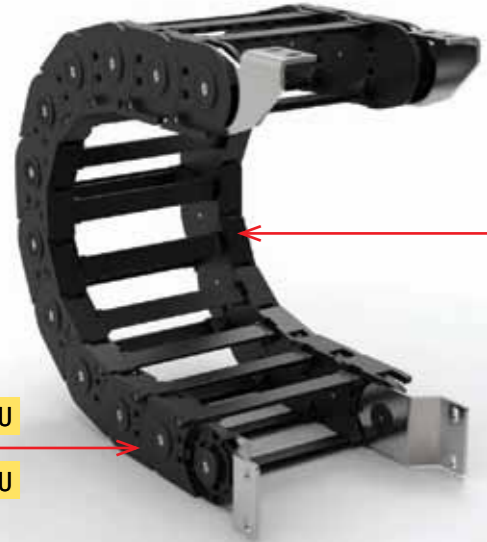

80MU

60MU



NYLON SKID

Skids are combined in synergy with rollers in order to provide the best performance.



IR-CHAIN

IR-Chains provide improved and longer-lasting performance.

GUIDE CHANNEL

A guide channel completes the Sliding Chain package. Channels are manufactured in zinc-plated steel, stainless steel, or aluminium.



TOTAL CHAIN



Brevetti Stendalto's plug-and-play system where the chain is pre-assembled with cables, hoses and connectors, and delivered to customers ready for installation. We can be a cable-chain system integrator by providing all-in-one system for industrial automation. We are ready to offer solutions for a wide range of applications: packaging, machine tools, textile industry, wood, marble and glass machining, transfer machinery, workbenches, etc. ... anything that can be harnessed!

ADVANTAGES

- Reduced assembly time.
- One single interlocutor/supplier.
- Warranty given over the full system.
- A simple and reliable solution.

COST EFFECTIVENESS

- Quicker and more efficient ordering process.
- Order the exact amount needed.
- No unused warehouse stock.
- Technical documentation: Our engineers use state-of-the-art CAD systems (EPLAN) to develop functional and construction drawings, datasheets, BOM and technical instructions.

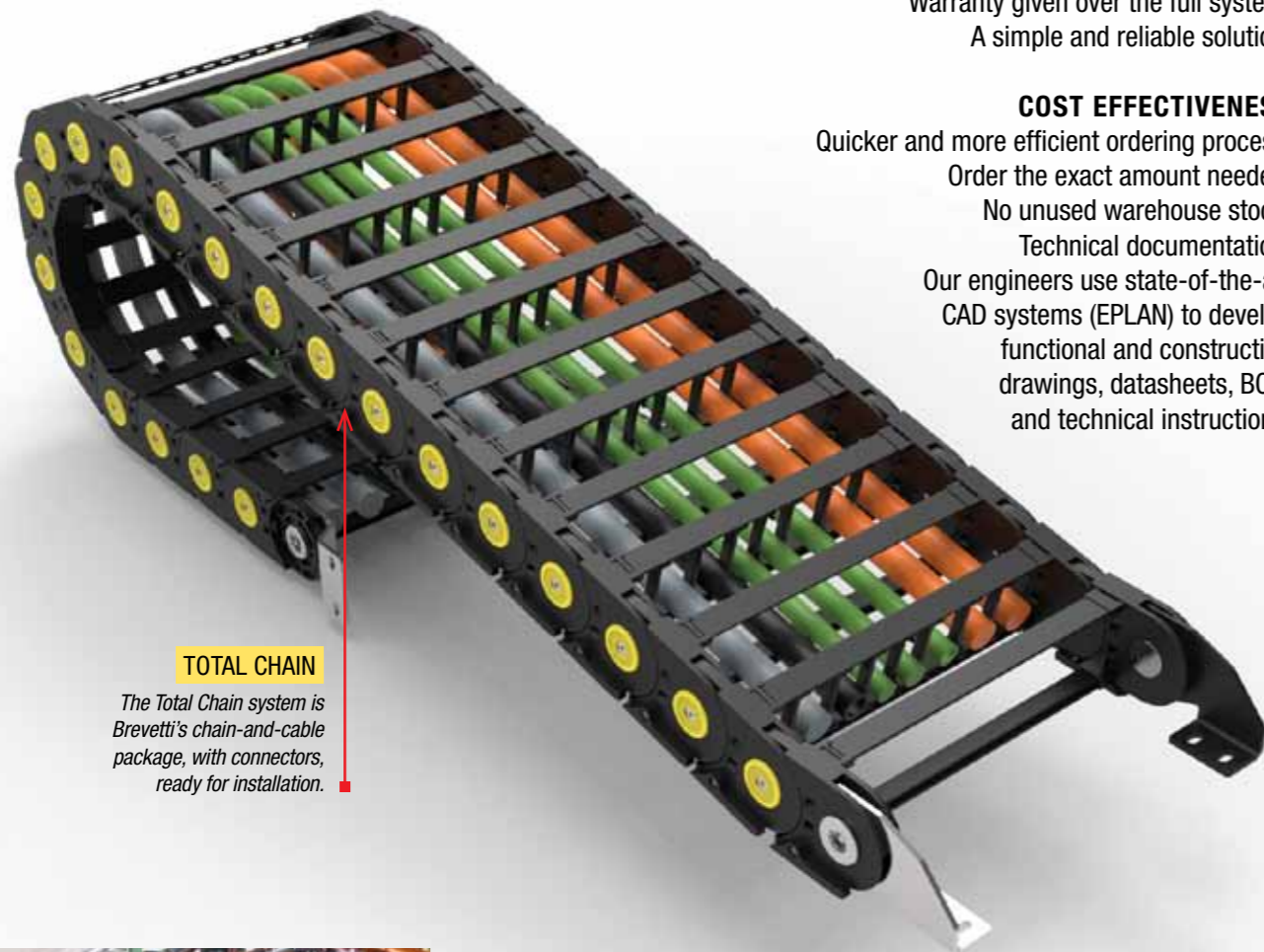

TOTAL CHAIN

The Total Chain system is Brevetti's chain-and-cable package, with connectors, ready for installation.



PACKAGING

We provide our chain systems rolled up around transportation drums, or secured to lifting frames, in plug-and-play Total Chain package, for fast and easy installation.

CONNECTORS

Brevetti Stendalto's cables are extra-flexible, specifically designed for use with cable chains, and complete with connectors. A large selection of flexible industrial and hydraulic hoses, with fittings, is also available.



ROBOTICS



Brevetti Stendalto's Multiflex chain is the solution for multi-dimensional movements, with special focus on robotics and new-generation machining centres. Multiflex enriches Brevetti Stendalto's Robot Series and presents customers with the opportunity to receive a complete dress package for their application from a single supplier. Multiflex is fully closed, but quick to open and easy to populate thanks to covers removable by screwdriver. Even after installation, every single part of the chain can be inspected and opened. Adding or removing links is also very easy.

NYLON END BRACKETS

End brackets feature various interchangeable elements, specifically designed for different applications. The comb is used to clamp cables with tie-wraps.









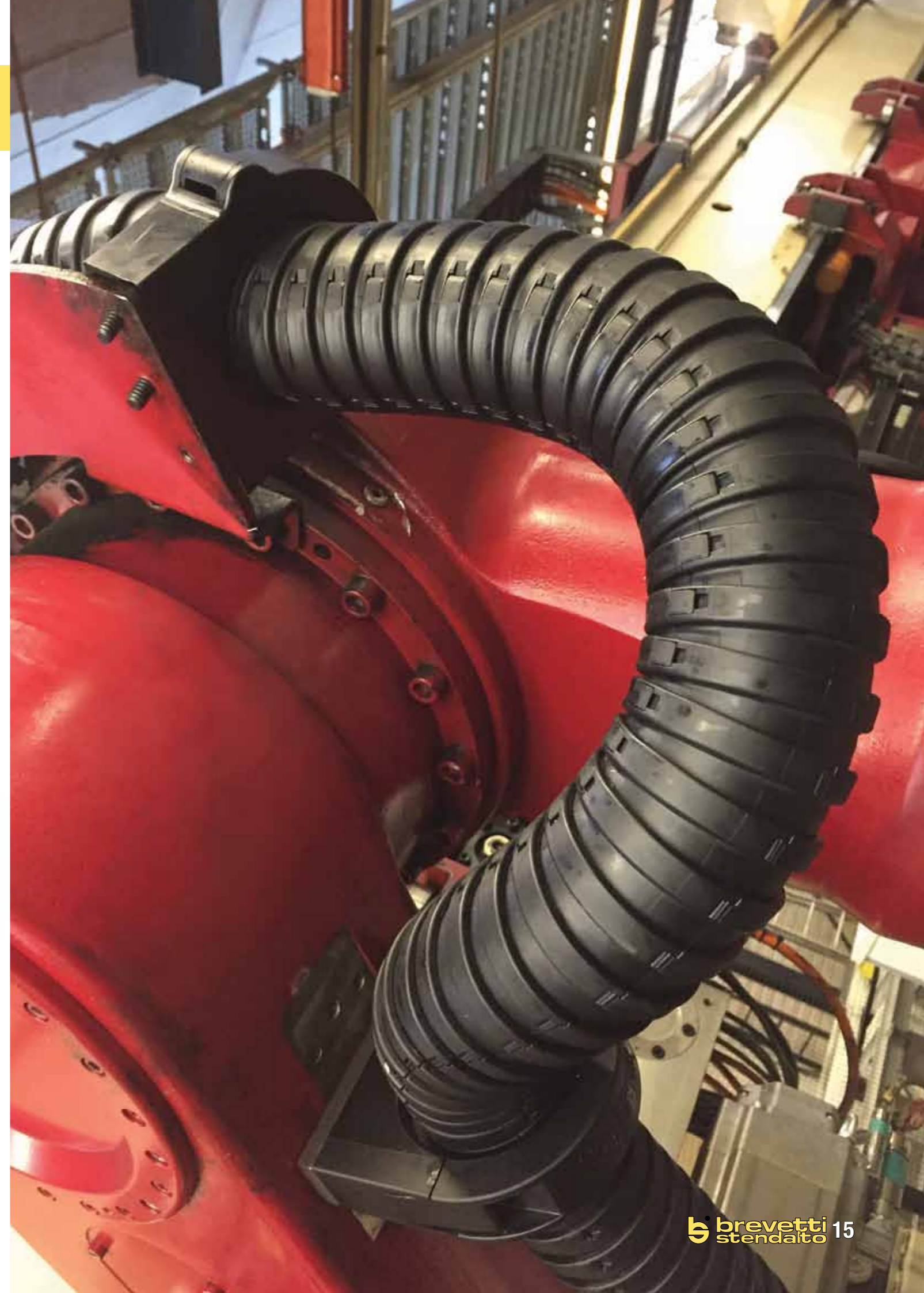
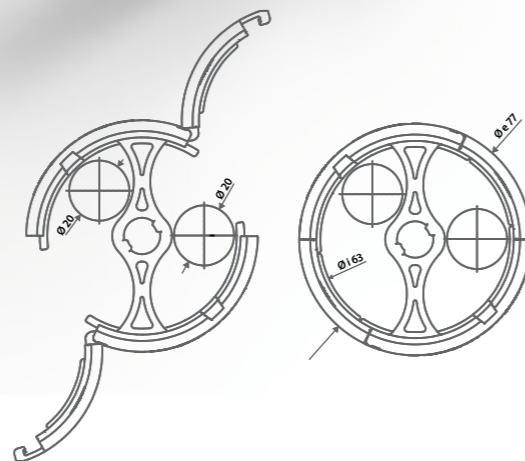

NYLON LINK

Scan the QR Code and have a look at Multiflex tutorial video on Brevetti Stendalto's YouTube channel.

Ø Inner mm	Ø Outer mm	Min. radius mm	Pitch mm	N. Pitches/m	Kg/m	Twist angle	Cable housing
63 mm	77 mm	100 mm	18.5	54	1,6	~±10° *	M. Ø 20 mm

* Defined as the single links



Overview of Products Range		Inner width		Inner height		External width		External height	Pitch	Bending radius		Self supported length		Max. travel length	Snap open cover		Enclosed design	Vertical separator	Horizontal separator	Ver./horiz. separator	Drilled frame	Diameter		
		from mm	to mm	from mm	to mm	from mm	to mm	mm	mm	from mm	to mm	max m	kg	mm	inner radius	outer radius						inner mm	outer mm	
Light serie 	40	200	12	35	12	-	18	41	15	17	18	40	0,90	0,1	-	-	-	-	-	-	-	-	-	
	42	250L/LI/LE	15	50	17	-	26	61	23	29	28	100	1,30	0,1	-	•	•	-	o	-	-	-	-	
	44	30090/91/92	18	38	18,5	-	29	49	23,5	30	33	100	1,45	0,1	o	-	-	-	-	-	-	-	-	
	46	325LI/LE	40	103	25	-	57	120	38	45	50	150	1,90	0,5	o	•	•	-	o	-	-	-	-	
	48	325L	40	103	25	-	57	120	38	45	50	150	1,90	0,5	o	-	-	-	o	-	-	-	-	
	50	335L/LI/LE	40	150	35	-	56,5	166,5	50	52	65	200	2,20	1	o	•	•	-	o	-	-	-	-	
	52	339	40	76	39	-	60	96	50	35	50	100	2,20	1	o	-	-	-	o	-	-	-	-	
Medium serie 	60	300A	15	75	18	-	27	87	23	30	40	120	1,70	0,1	-	•	-	-	-	-	-	-	-	
	62	300	14	36	18	-	30	52	23	30	40	120	1,55	0,1	o	-	-	-	-	-	-	-	-	
	64	305A	30	50	24	-	54	74	30	35	50	150	1,40	1	-	•	-	-	o	-	-	-	-	
	66	305	30	50	23	-	52	72	30	35	50	150	1,90	1	o	-	-	-	o	-	-	-	-	
	68	355A	45	95	31	-	74	124	43	40	75	200	2,30	1	-	•	-	-	o	-	-	-	-	
	70	355	45	95	30	-	74	124	45	40	75	200	2,30	1	o	-	-	-	o	-	-	-	-	
	72	400	40	60	25	-	62	82	35	40	50	150	1,60	1	-	•	-	-	o	-	-	-	-	
	74	435MU	40	150	35	-	60	170	49	50	60	200	2,20	1	o	•	•	-	o	-	-	-	-	
	76	445MU	50	362	45	-	72	384	64	67	75	300	3,70	1	o	•	•	-	o	o	o	o	-	-
	78	660A	50	362	37	-	75	387	55	50	100	250	2,45	1	o	•	-	-	o	o	o	o	-	-
	80	770A	45	357	60	-	80	392	78	70	150	300	3,80	1	o	•	-	-	o	o	o	o	-	-
82	475MU	74	498	75,5	-	112	536	100,5	105	150	400	4,75	1	o	•	•	-	o	o	o	o	-	-	
Heavy serie 	88	H57	75	500	57	-	113	538	85	90	150	400	5,00	1	-	•	•	o	o	o	o	-	-	
	90	H80	64	400	70	75,5	120	456	100	120	200	750	6,00	1	-	•	•	o	o	o	o	o	-	-
	92	H110	200	600	112	-	260	660	150	160	200	750	9,00	1	-	•	•	o	o	o	o	o	-	-
	96	306	43	355	30	37	79	391	55	65	75	300	3,10	1	-	•	•	o	o	o	o	o	-	-
	100	307	42	354	40	47	80	392	64	70	75	250	3,90	1	-	•	•	o	o	o	o	o	-	-
	106	308	38	350	48	57	82	394	75	80	150	400	4,95	1	-	•	•	o	o	o	o	o	-	-
	112	309	64	400	70	75,5	120	456	100	100	200	500	6,50	1	-	•	•	o	o	o	o	o	-	-
	116	310	200	600	112	-	260	660	150	145	200	750	7,00	1	-	•	•	o	o	o	o	o	-	-
	Protection serie 	126	325PI	10	103	25	-	57	120	38	45	75	150	1,70	0,5	-	•	-	•	o	o	o	-	-
128		335PS	40	150	35	-	56,5	166,5	50	52	65	200	2,00	1	-	•	-	-	o	-	-	-	-	
130		435PU	40	150	35	-	60	170	48	50	75	200	2,10	1	-	•	•	•	o	o	o	-	-	
132		445PU	50	362	45	-	72	384	64	67	100	300	3,35	1	-	•	•	•	o	o	o	-	-	
134		445PS	61	125	45	-	83	147	64	67	100	300	3,35	1	•	•	•	•	o	o	o	-	-	
136		445AU	50	362	45	-	72	384	64	67	100	300	3,35	1	-	•	•	•	o	o	o	-	-	
138		475PU	74	374	75,5	-	110	410	100,5	105	180	400	4,45	1	-	•	•	•	o	o	o	-	-	
140		660	50	150	36	-	79	179	55	50	100	250	2,30	1	-	•	-	•	o	o	o	-	-	
142		770	85	250	51	-	120	285	78	70	150	300	3,45	1	-	•	-	•	o	o	o	-	-	
144		306CU	43	355	37	-	79	391	55	65	107	300	2,70	1	-	•	•	•	o	o	o	-	-	
146		308CU	38	350	57	-	82	394	75	80	180	400	4,00	1	-	•	•	•	o	o	o	-	-	
148		309C	200	400	72	-	256	456	100	100	200	500	5,80	1	-	-	•	•	•	o	o	o	-	-
150		309CU	64	488	75,5	-	120	544	100	100	200	500	6,00	1	-	•	•	•	•	o	o	o	-	-
Sliding serie 		154	326	61	373	30	37	89	416	59	65	107	300	-	-	•	•	•	o	o	o	o	-	-
	158	328	61	373	48	57	116	428	79	80	150	400	-	-	•	•	•	o	o	o	o	-	-	
	162	319	64	400	70	75,5	128	464	107	100	200	500	-	-	•	•	•	-	o	o	o	o	-	-
	166	329	64	488	75,5	-	128	552	107	100	150	600	-	-	•	•	•	o	o	o	o	-	-	
	172	478	74	498	75,5	-	112	536	106,5	105	150	400	-	-	•	•	•	o	o	o	o	-	-	
	176	60PU	115	539	60,5	-	165	589	90	90	150	400	-	-	•	•	•	-	o	o	o	-	-	
	178	80PU	115	539	80,5	-	195	619	117	110	200	700	-	-	•	•	•	-	o	o	o	-	-	
Robot serie 	188	495	45	-	35	-	69	-	45	-	100	-	-	-	•	-	-	-	-	-	-	600	755	
	190	500	65	-	30	-	93	-	43	-	100	150	-	-	-	•	-	-	-	-	-	630	830	
	192	510TN	88	-	46	-	132	-	55-77	-	125	-	-	-	-	•	-	-	-	-	-	940	1220	
	192	515TN	88	-	46	-	132	-	55-77	-	175	-	-	-	-	•	-	-	-	-	-	1060	1340	
	194	545	62	-	46	-	123	-	62	-	100	-	-	-	-	•	-	-	o	o	o	-	-	
	196	599	210	-	59	-	272	-	85	-	220	-	-	-	-	•	•	-	o	o	o	-	-	
Steel serie 	202	20LT	79	304	32	-	111	336	53	75	75	305	3,90	1	o	-	-	o	•	o	o	-	-	
	204	20LC	79	304	32	-	111	336	53	75	115	305	4,20	1	o	-	-	o	•	o	o	-	-	
	206	30LT	106	506	52	58	140	540	74	95	150	535	5,50	1	-	-	-	o	o	o	o	-	-	
	208	30LC	106	506	52	-	140	540	74	95	150	535	5,00	1	-	-	-	•	o	o	o	-	-	
	210	35LT	104	504	65	70	148	548	95	125	200	600	7,25	1	-	-	-	o	o	o	o	-	-	
	212	35LC	104	504	65	-	148	548	95	125	200	600	7,00	1	-	-	-	•	o	o	o	-	-	
	214	40LT	150	500	112,5	-	208	558	145	180	250	850	12,90	1	o	-	-	o	o	o	o	-	-	
	216	40LC	150	500	112,5	-	208	558	145	180	250	850	11,8	1	o	-	-	•	o	o	o	-	-	
	218	42LT	150	500	138	-	208	558	175	180	250	850	12	1	o	-	-	-	o	o	o	-	-	
	220	45T	300	600	182	180	390	690	220	250	400	1500	13,00	1	-	-	-	o	o	o	o	-	-	
	222	20NT	79	304	32	38																		

CHAINCONFIGURATOR

BS-WEBSITE

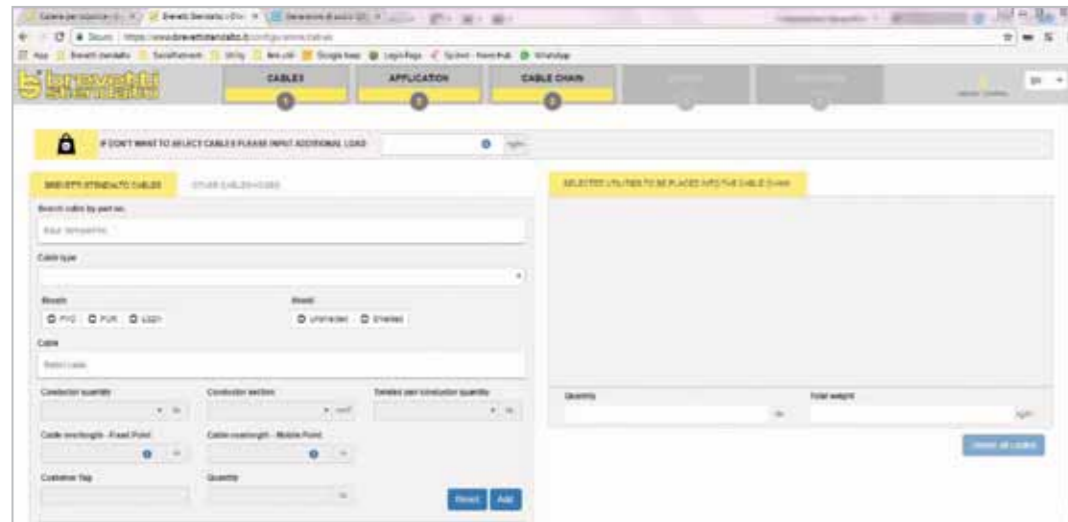

1 In 2017 Brevetti Stendalto launched an online chain configurator, accessible from Brevetti's website. With the configurator everyone can log on and build up their own chain and relevant accessories. Through a simple, user-friendly web interface, it will be a matter of minutes to fill in the required fields and see the chain getting shaped step by step.

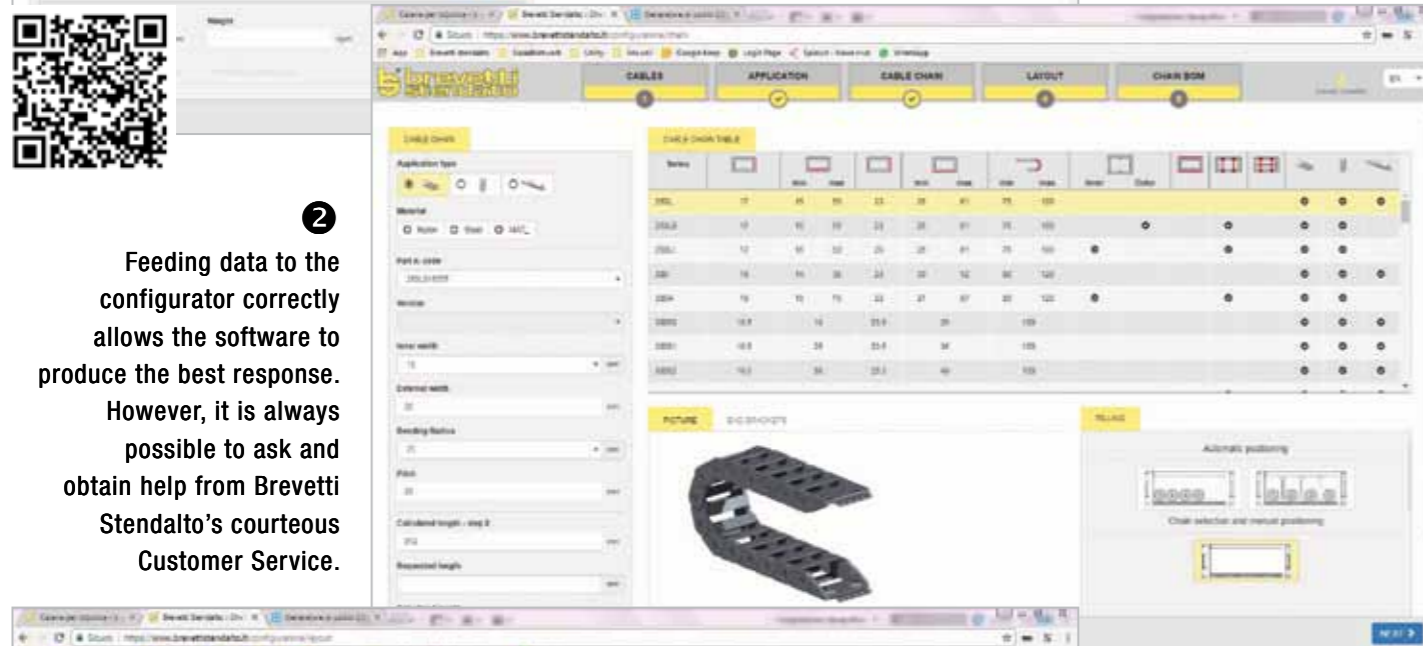

2 Feeding data to the configurator correctly allows the software to produce the best response. However, it is always possible to ask and obtain help from Brevetti Stendalto's courteous Customer Service.

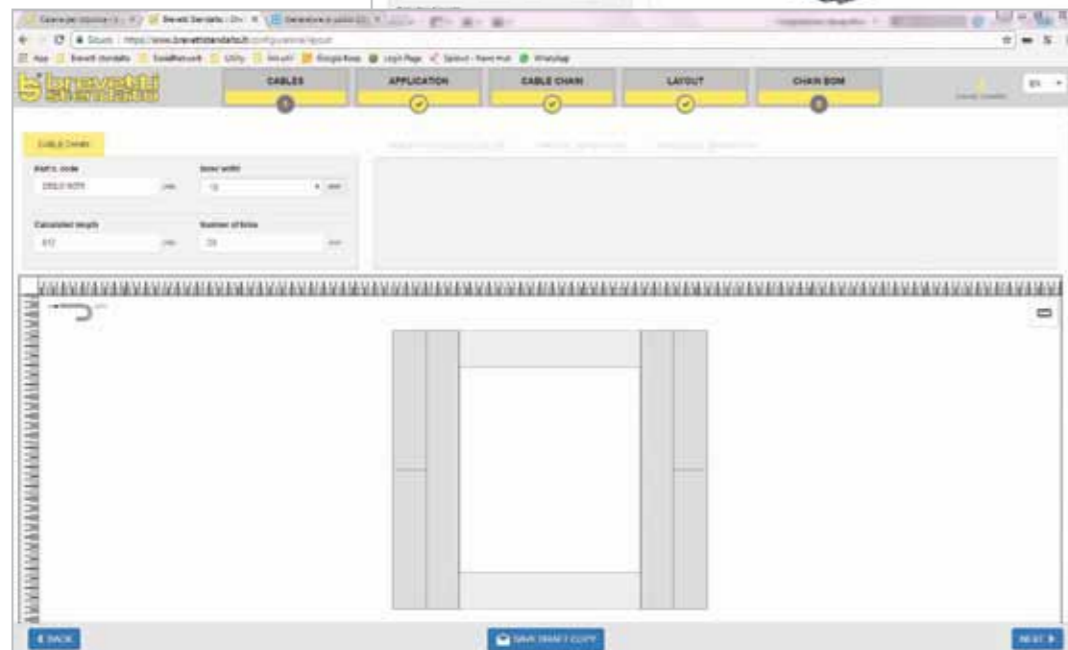

3 The configuration includes the whole Total Chain package, with cables and hoses and their position inside the chain. At the end of the configuration process, a bill of material is automatically generated. The corresponding PDF file can be saved for future modifications or re-use, or sent to Brevetti Stendalto for processing.

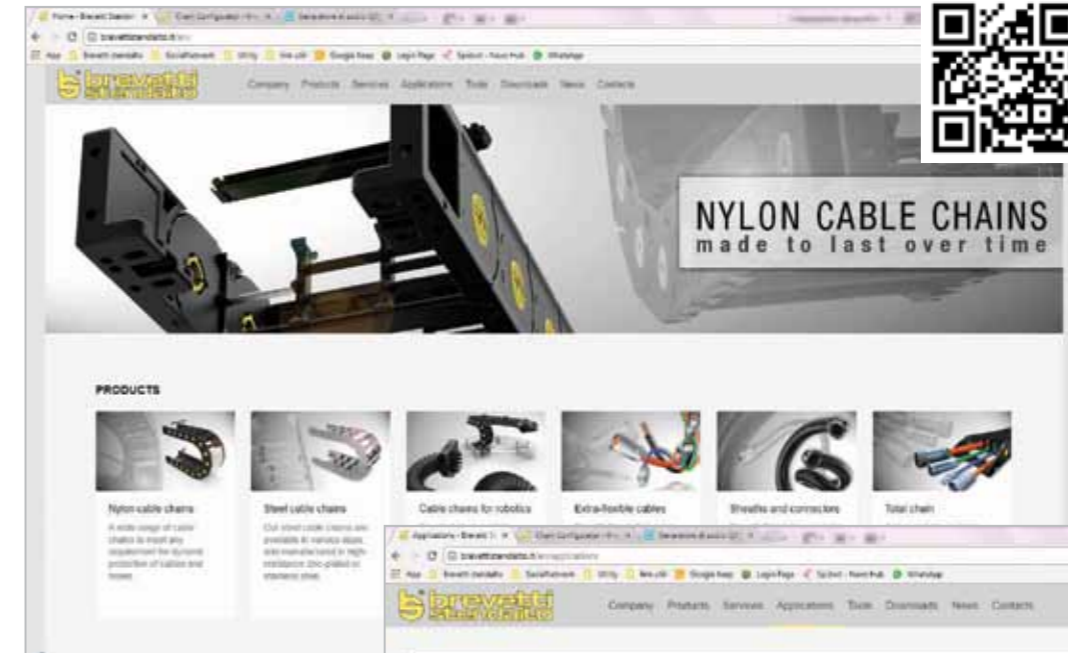

1 Brevetti Stendalto's website is brand new. It was re-designed to be intuitive and practical to browse within. The homepage shows all the main areas of the site, including product information divided by type, 2D drawings and 3D models, the chain configurator, techno-commercial enquiry, and much more.

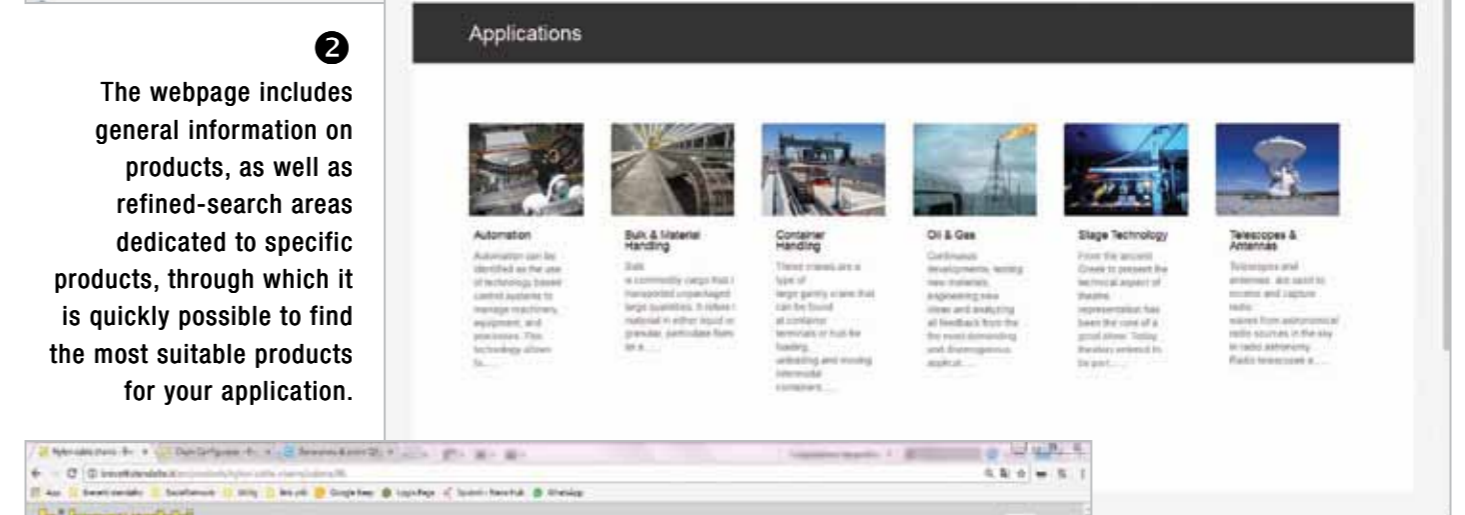

2 The webpage includes general information on products, as well as refined-search areas dedicated to specific products, through which it is quickly possible to find the most suitable products for your application.

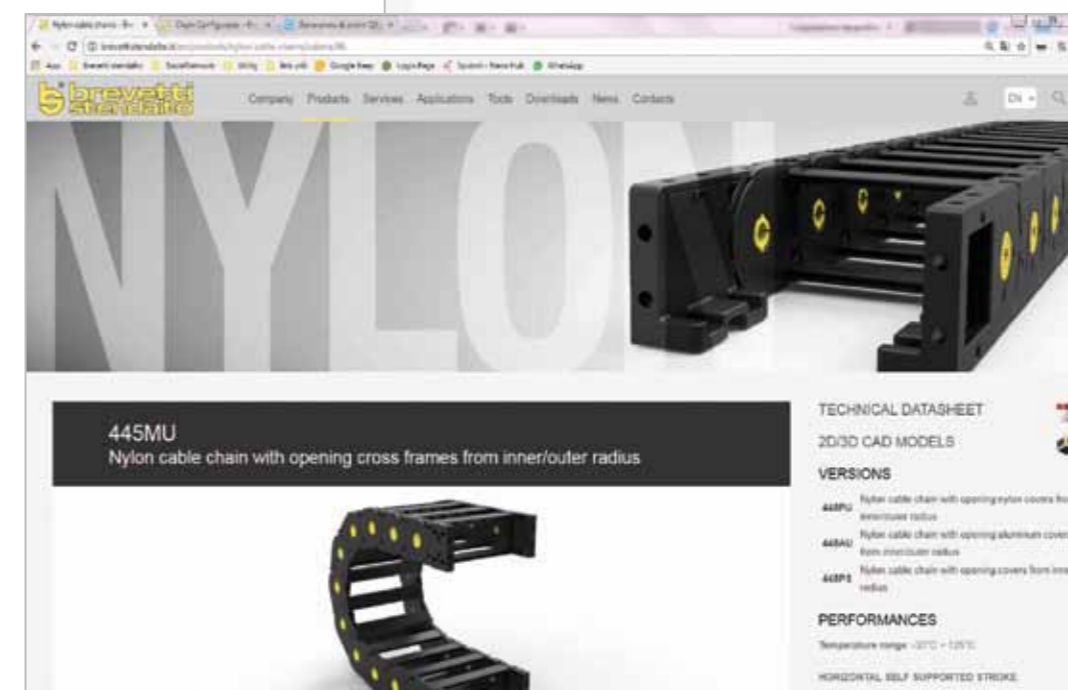

3 Online technical datasheets are available for every product, providing specific information on construction and utilisation, and can be download. A dedicated area of the website includes brochures, leaflets, and various technical documentation. Documents are available in up to five languages (English, Italian, French, German, and Chinese).

HEADQUARTERS

Brevetti Stendalto SpA
V.le G. Battista Stucchi 66/8
20900 Monza

T. +39 039 204901
F. +39 039 834250

info@brevettistendalto.it

FRANCE

Brevetti France

23,25 Rue Roger Salengro
BP79
69744 Genas Cedex

T. +33 4 72791960
F. +33 4 72791969

info@brevettifrance.fr

GERMANY

Brevetti Stendalto GmbH

D-72622 Nürtingen
Hohes Gestade 16

T. +49 (0) 7022 9790083
F. +49 (0) 7022 9790084

info@brevettistendalto.de

UNITED STATES

Brevetti Inc.

Charlotte, NC 28217
3845 Shopton Road Suite 350

T. +1 704 5880888
F. +1 704 5880333

info@brevettiusa.com

CHINA

Brevetti Drag Chain Systems
(Shanghai) Co., Ltd
No. 818 Jiuxin Road, Building D room 101
Songjiang District
Shanghai 201615, PR China

T. +86 21 50778163
F. +86 21 50719318

info@bshanghai.com.cn

 **brevetti
stendalto**

WWW.BREVETTISTENDALTO.COM